

## Praetorian™ 4-Channel LCD Camera EMI Filter Array with ESD Protection

### Features

- 4 channels of EMI filtering
- $\pm 15\text{kV}$  ESD protection (IEC 61000-4-2, contact discharge)
- $\pm 30\text{kV}$  ESD protection (HBM)
- Greater than  $-40\text{dB}$  of attenuation at  $1\text{GHz}$
- Chip Scale Package (CSP) with  $0.40\text{mm}$  pitch and  $0.25\text{mm}$  CSP solder ball which features extremely low parasitic inductance for optimum filter and ESD performance
- *OptiGuard™* Coating for improved reliability at assembly
- RoHS compliant

### Applications

- LCD and Camera data lines in mobile handsets
- I/O port protection for mobile handsets, notebook computers, PDAs etc.
- EMI filtering for data ports in cell phones, PDAs or notebook computers.
- Wireless handsets
- Handheld PCs/PDAs
- LCD and camera modules

### Product Description

The CM1453-04CP is a pi-style EMI filter array with ESD protection, which integrates four filters (C-L-C) in CSP form factor with  $0.40\text{mm}$  pitch. Each EMI filter

channel of the CM1453-04CP is implemented as a 3-pole L-C filter where the component values are  $9.5\text{pF}$ - $20\text{nH}$ - $9.5\text{pF}$ . The roll-off frequency at  $-6\text{dB}$  attenuation is  $380\text{MHz}$  and can be used in applications where the data rates are as high as  $160\text{Mbps}$  while providing greater than  $-35\text{dB}$  over the  $800\text{MHz}$  to  $2.7\text{GHz}$  frequency range. The parts include ESD diodes on every I/O pin, that provide a high level of protection against electrostatic discharge (ESD). The ESD protection diodes connected to the filter ports are designed and characterized to safely dissipate ESD strikes of  $\pm 15\text{kV}$ , beyond the maximum requirement of the IEC61000-4-2 international standard. Using the MIL-STD-883 (Method 3015) specification for Human Body Model (HBM) ESD, the pins are protected for contact discharges at greater than  $\pm 30\text{kV}$ .

This device is particularly well suited for wireless handsets, mobile LCD modules and PDAs because of its small package format and easy-to-use pin assignments. In particular, the CM1453-04CP is ideal for EMI filtering and protecting data and control lines for the LCD display and camera interface in mobile handsets.

The CM1453-04CP incorporates *OptiGuard™* which results in improved reliability at assembly. It is manufactured with a  $0.40\text{mm}$  pitch and  $0.25\text{mm}$  CSP solder ball to provide up to  $28\%$  board space savings vs. competing CSP devices with  $0.50\text{mm}$  pitch and  $0.30\text{mm}$  CSP solder ball.

### Electrical Schematic

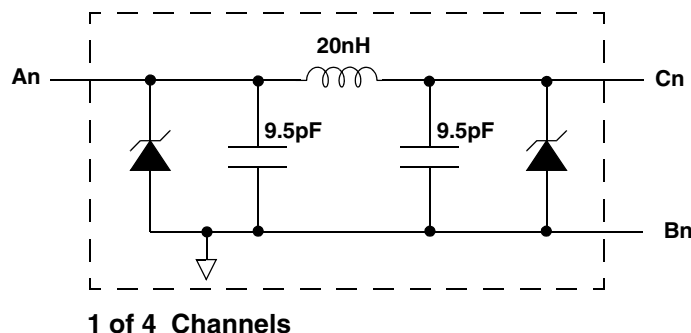

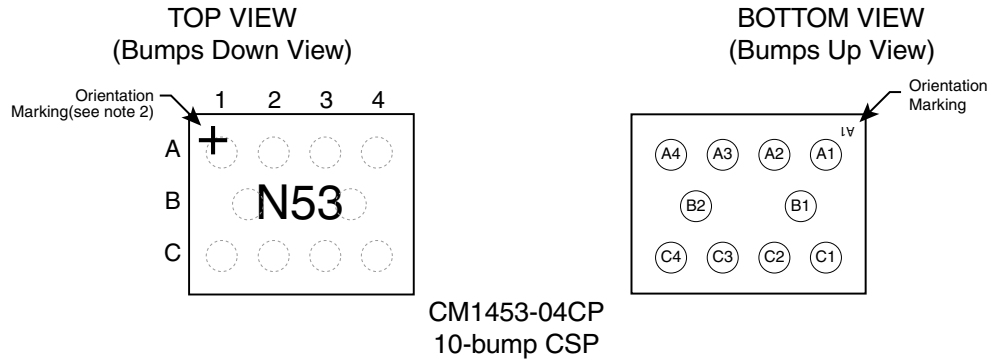
**PACKAGE / PINOUT DIAGRAMS**

**Notes:**

1) These drawings are not to scale.

**PIN DESCRIPTIONS**

PIN NUMBER	PIN DESCRIPTION	PIN NUMBER	PIN DESCRIPTION
A1	Filter #1	C1	Filter #1
A2	Filter #2	C2	Filter #2
A3	Filter #3	C3	Filter #3
A4	Filter #4	C4	Filter #4
B1	GND	-	
B2	GND	-	

**Ordering Information**
**PART NUMBERING INFORMATION**

Bumps	Package	Lead-free Finish	
		Ordering Part Number <sup>1</sup>	Part Marking
10	CSP	CM1453-04CP	N53

Note 1: Parts are shipped in Tape &amp; Reel form unless otherwise specified.

## Specifications

### ABSOLUTE MAXIMUM RATINGS

PARAMETER	RATING	UNITS
Storage Temperature Range	-65 to +150	°C
DC current per Inductor	30	mA
DC Package Power Rating	0.5	W

### STANDARD OPERATING CONDITIONS

PARAMETER	RATING	UNITS
Operating Temperature Range	-40 to +85	°C

### ELECTRICAL OPERATING CHARACTERISTICS (NOTE 1)

SYMBOL	PARAMETER	CONDITIONS	MIN	TYP	MAX	UNITS
$L_{TOT}$	Total Channel Inductance			20		nH
$C_{TOT}$	Total Channel Capacitance ( $C_1 \times 2$ )	2.5V dc; 1MHz, 30mV ac	15.2	19	22.8	pF
$C_1$	Capacitance	2.5V dc; 1MHz, 30mV ac		9.5		pF
$V_{ST}$	Stand-off Voltage	$I = 10\mu A$	5.5			V
$I_{LEAK}$	Diode Leakage Current	$V_{IN} = +3.3V$		0.1	1.0	$\mu A$
$V_{SIG}$	Signal Clamp Voltage Positive Clamp Negative Clamp	$I_{LOAD} = 10mA$ $I_{LOAD} = -10mA$	5.6 -1.5	6.8 -0.8	9.0 -0.4	V V
$V_{ESD}$	In-system ESD Withstand Voltage a) Human Body Model, MIL-STD-883, Method 3015 b) Contact Discharge per IEC 61000-4-2 Level 4	Notes 2, 3, 4 and 5	$\pm 30$ $\pm 15$			kV kV
$f_C$	Cut-off frequency $Z_{SOURCE} = 50\Omega$ , $Z_{LOAD} = 50\Omega$			300		MHz
$f_C$	Roll-off frequency at -6dB Attenuation $Z_{SOURCE} = 50\Omega$ , $Z_{LOAD} = 50\Omega$			380		MHz
$R_{DYN}$	Dynamic Resistance Positive Negative			2.3 0.9		$\Omega$ $\Omega$

Note 1:  $T_A = 25^\circ C$  unless otherwise specified.

Note 2: ESD applied to input and output pins with respect to GND, one at a time.

Note 3: Unused pins are left open.

Note 4: These parameters are guaranteed by design and characterization.

### Performance Information

Typical Filter Performance (nominal conditions unless specified otherwise, 50 Ohm Environment)

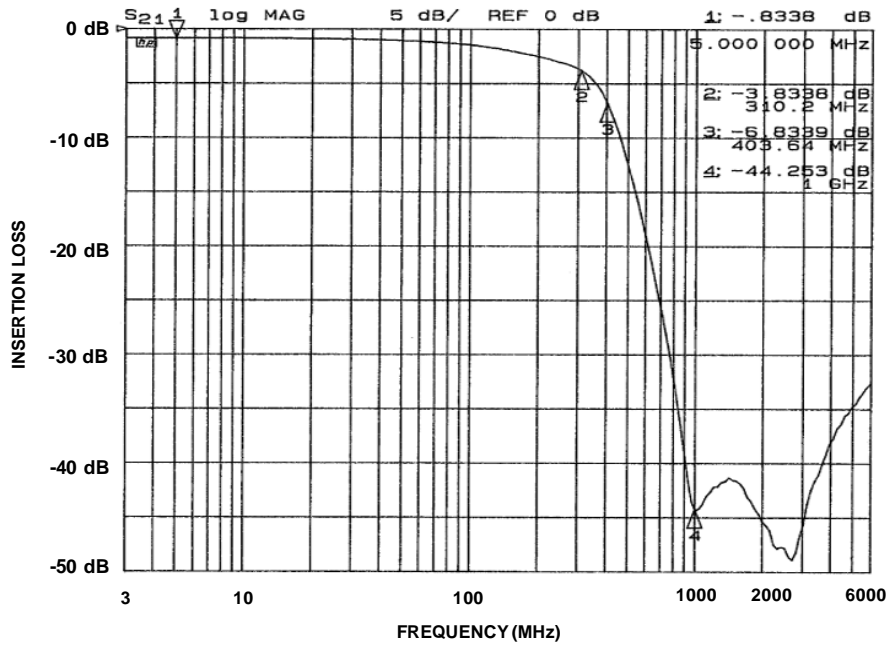

Figure 1. Insertion Loss VS. Frequency (CM1453-04: Filter 1)

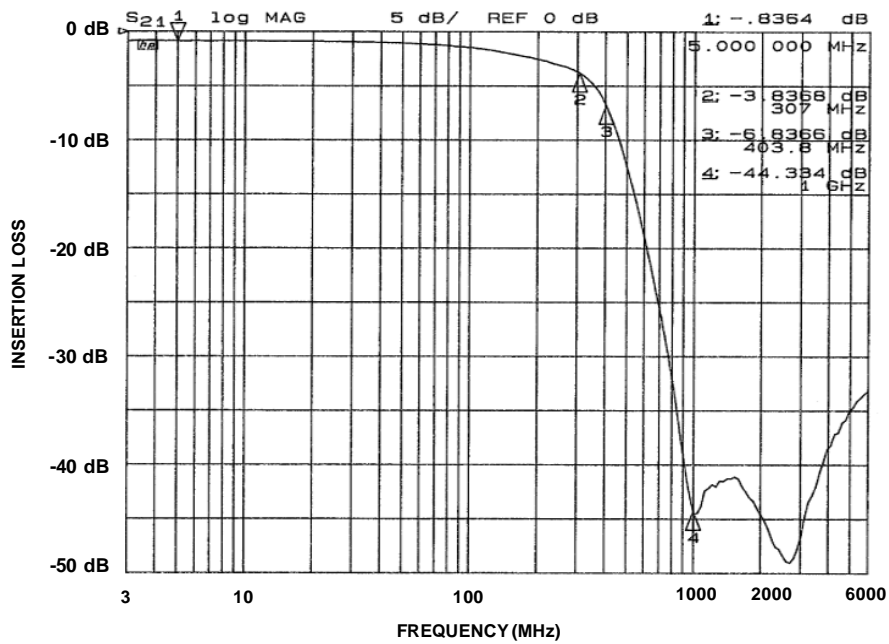
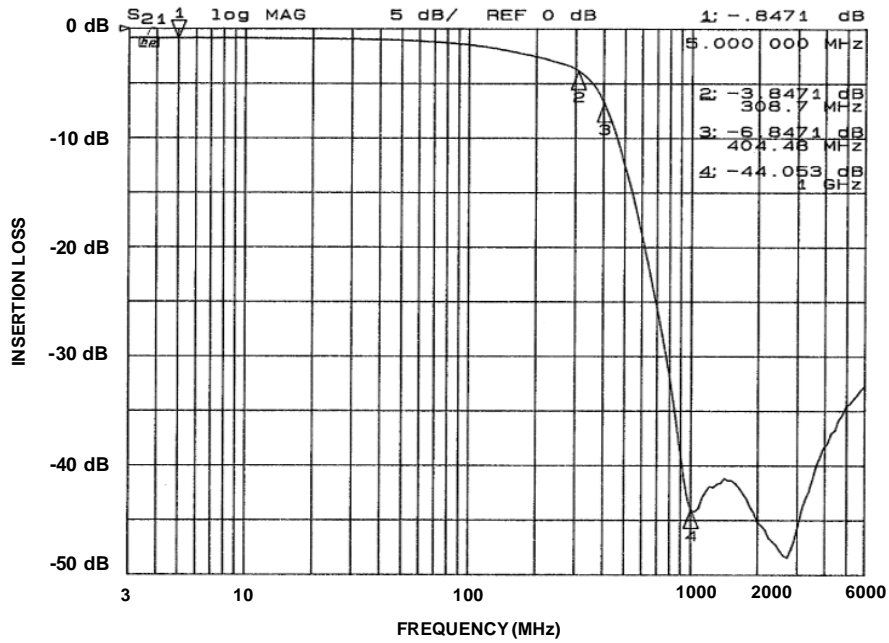
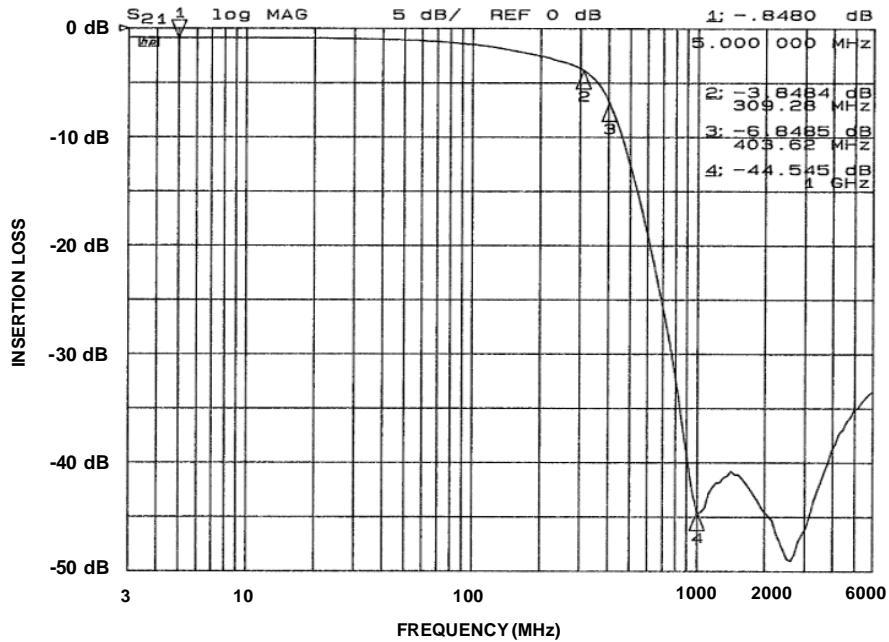

Figure 2. Insertion Loss VS. Frequency (CM1453-04: Filter 2)



**Figure 3. Insertion Loss VS. Frequency (CM1453-04: Filter 3)**



**Figure 4. Insertion Loss VS. Frequency (CM1453-04: Filter 4)**

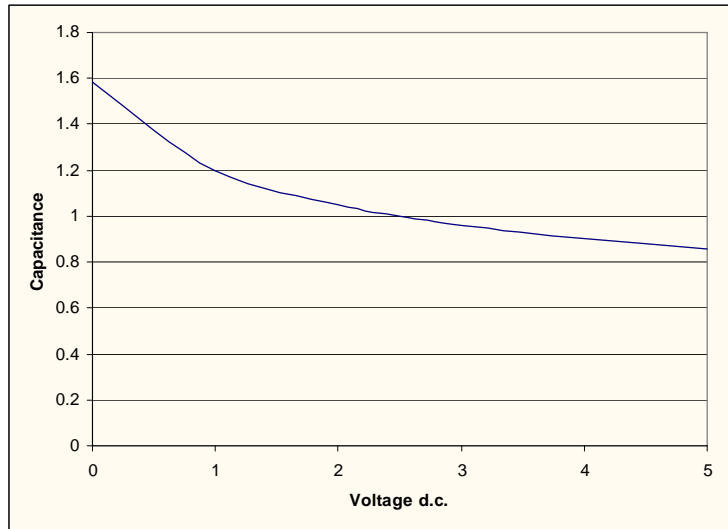

**Figure 5. Typical Diode Capacitance vs. Input Voltage (normalized to 2.5V d.c)**

### Application Information

Refer to Application Note AP-217, "The Chip Scale Package", for a detailed description of Chip Scale Packages offered by California Micro Devices. See <http://www.wlcsforum.org/documents/pdf/ap-217.pdf> for download.

## Mechanical Specifications

CM1453 devices are packaged in custom Chip Scale Packages (CSP). See Application Note AP-217 for more information at: <http://www.wlcsforum.org/documents/pdf/ap-217.pdf>

PACKAGE DIMENSIONS						
Package	Custom CSP					
Bumps	10					
Dim	Millimeters			Inches		
	Min	Nom	Max	Min	Nom	Max
A1	1.629	1.674	1.719	0.0641	0.0659	0.0677
A2	1.099	1.144	1.189	0.0433	0.0450	0.0468
B1	0.395	0.400	0.405	0.0156	0.0157	0.0159
B2	0.195	0.200	0.205	0.0077	0.0079	0.0081
B3	0.342	0.347	0.352	0.0135	0.0137	0.0139
B4	0.342	0.347	0.352	0.0135	0.0137	0.0139
C1	0.187	0.237	0.287	0.0074	0.0093	0.0113
C2	0.175	0.225	0.275	0.0069	0.0089	0.0108
D1	0.545	0.615	0.685	0.0215	0.0242	0.0270
D2	0.368	0.419	0.470	0.0145	0.0165	0.0185
# per tape and reel	3500 pieces					
Controlling dimension: millimeters						

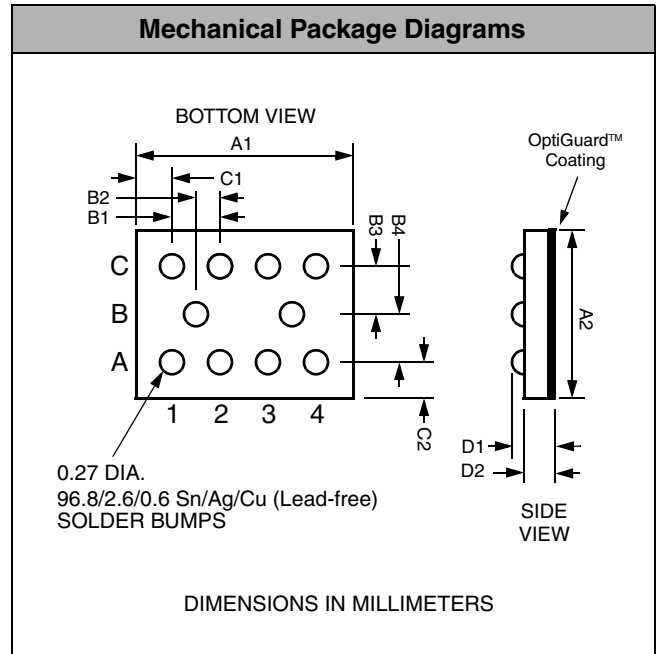

Package Dimensions for  
CM1453-04CP Chip Scale Package

## CSP Tape and Reel Specifications

PART NUMBER	CHIP SIZE (mm)	POCKET SIZE (mm) $B_0 \times A_0 \times K_0$	TAPE WIDTH W	REEL DIAMETER	QTY PER REEL	$P_0$	$P_1$
CM1453-04CP	1.67 X 1.14 X 0.615	1.80 X 1.27 X 0.73	8mm	178mm (7")	3500	4mm	4mm

